



Holy Enterprise Limited

FL.2, No.12 North Ave.1, Industrial Rd. East, Gusan, Guzhen, Zhongshan, Guangdong, China

Specification

6-FM-24 12V24AH/20HR

Cells Per Unit	6
Voltage Per Unit	12
Capacity	24AH@20hr-rate to 1.8V per cell @ 25°C
Weight	Approx.7.4kg (Tolerance±3%)
Max. Discharge Current	240 A(5sec)
Internal Resistance	Approx 15 mΩ
Operating Temperature	Discharge: -20°C~50°C Charge: 0°C~40°C Storage: -20°C~50°C
Normal Operating Temperature	25±3°C
Float Charging Voltage	2.25 to 2.27 VDC/unit Average at 25°C
Maximum Charging Current	6.0A
Equalization and Cycle service	2.35 to 2.40 VDC /unit Average at 25°C
Terminal	Terminal: NB/B



Application

Alarm Systems
Electronic Toys
Medical Equipment
Cable Television
Communications Equipment
Electronic Cash Registers
Electric Test Equipment
Emergency lighting Systems
UPS

Dimension: 165(L) ×126(W) ×174(H) (Total 174 mm)

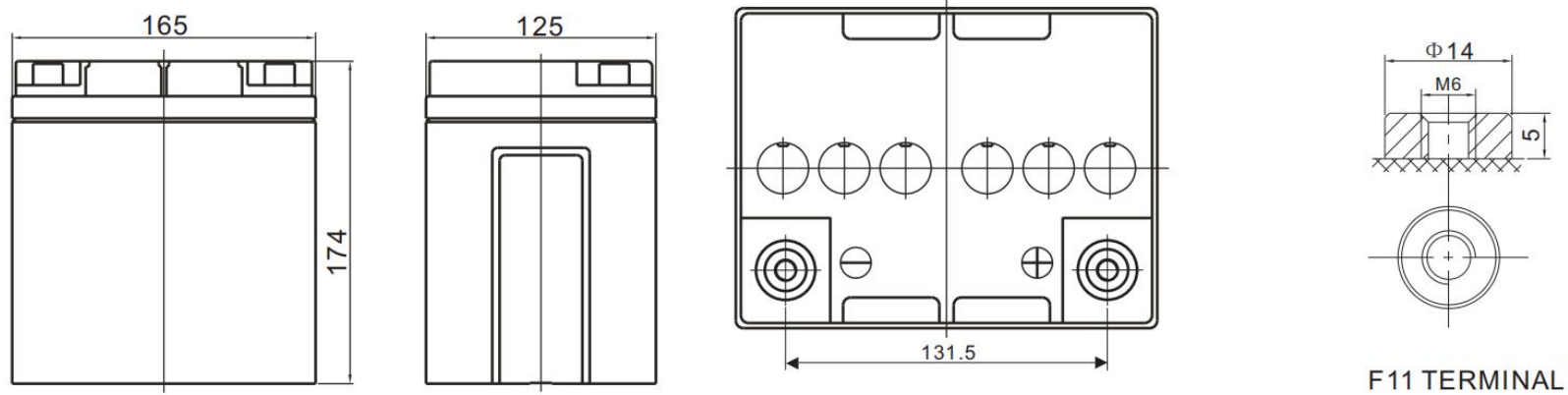

Constant Current Discharge Characteristics: A(25°C)												
F.V/Time	5MIN	10MIN	15MIN	30MIN	60MIN	2HR	3HR	4HR	5HR	8HR	10HR	20HR
1.80V/cell	54.24	42.75	33.32	21.07	12.06	7.84	6.00	4.90	4.079	2.750	2.243	1.188
1.75V/cell	61.78	47.22	36.09	22.04	12.54	8.13	6.19	5.04	4.187	2.797	2.272	1.200
1.70V/cell	68.95	51.59	38.78	23.06	13.01	8.43	6.38	5.17	4.295	2.837	2.302	1.215
1.65V/cell	76.42	56.04	41.41	24.13	13.45	8.72	6.56	5.32	4.410	2.881	2.338	1.230
1.60V/cell	82.18	59.30	43.31	25.13	13.93	9.00	6.77	5.46	4.527	2.914	2.367	1.250

Constant Power Discharge Characteristics: W/Unit(25°C)												
F.V/Time	5MIN	10MIN	15MIN	30MIN	60MIN	2HR	3HR	4HR	5HR	8HR	10HR	20HR
1.80V/cell	582.7	468.7	370.4	239.1	139.26	91.02	69.90	57.24	47.88	32.52	26.58	14.10
1.75V/cell	649.8	508.9	395.6	247.7	143.94	93.90	71.88	58.68	48.96	33.00	26.88	14.22
1.70V/cell	709.8	546.1	419.0	256.5	148.50	96.84	73.74	60.00	50.04	33.36	27.24	14.40
1.65V/cell	769.2	582.5	440.8	265.7	152.52	99.60	75.48	61.44	51.18	33.84	27.60	14.58
1.60V/cell	817.2	604.8	454.3	273.8	157.08	102.36	77.58	62.94	52.38	34.14	27.90	14.76

All mentioned values are average values.

Discharge Characteristics Curve

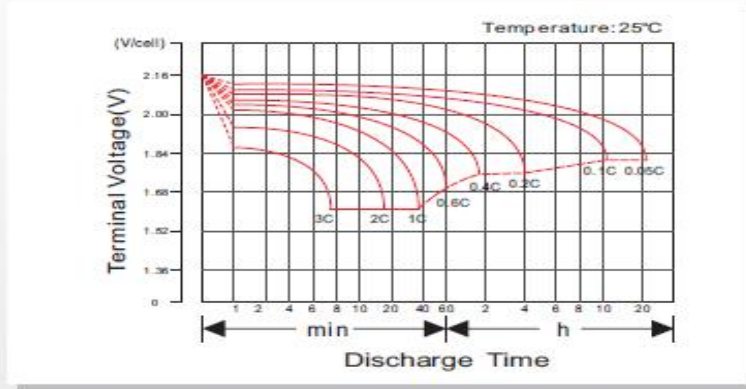

Charging Characteristics Curve

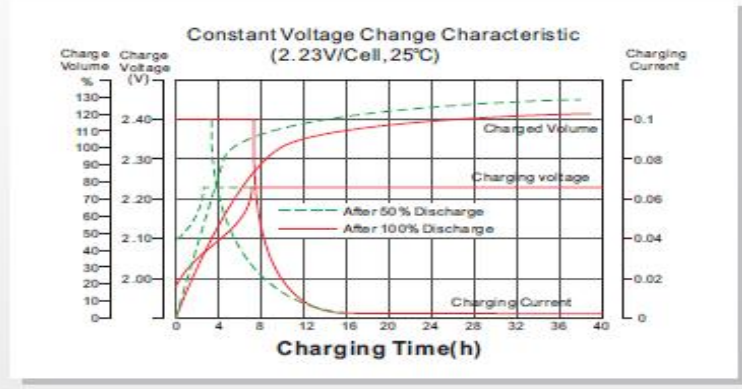

Cycle life in relation to depth of Discharge

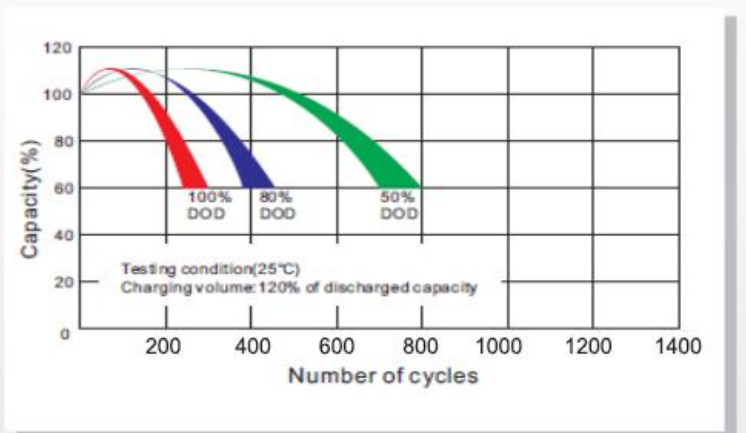

Temperature effects on Capacity

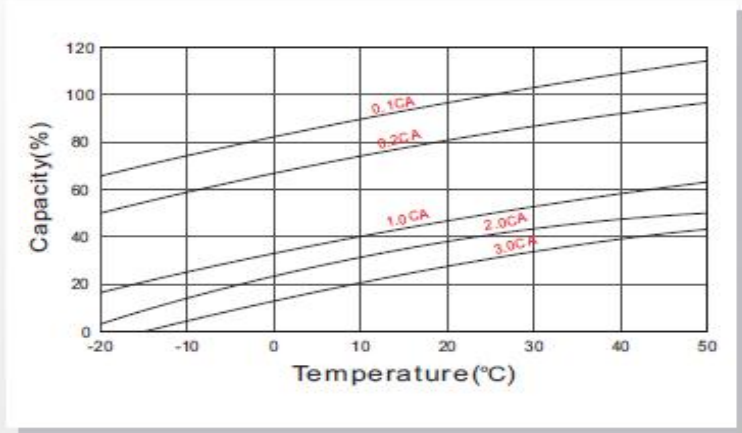

Relationship between charging voltage and temperature

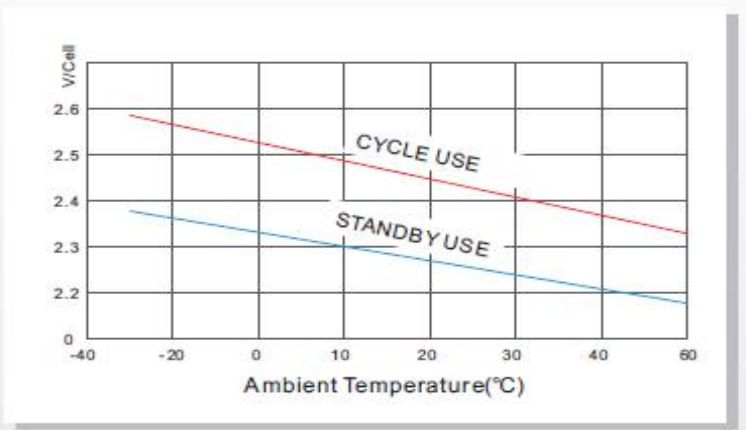

Self-discharge Characteristics

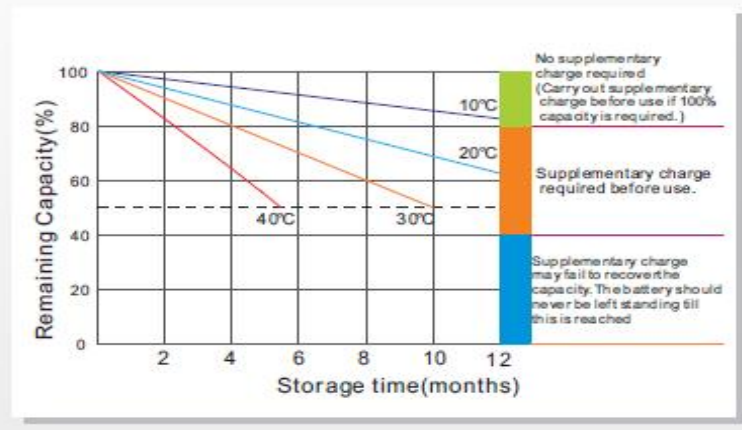

Temperature effects on Float life

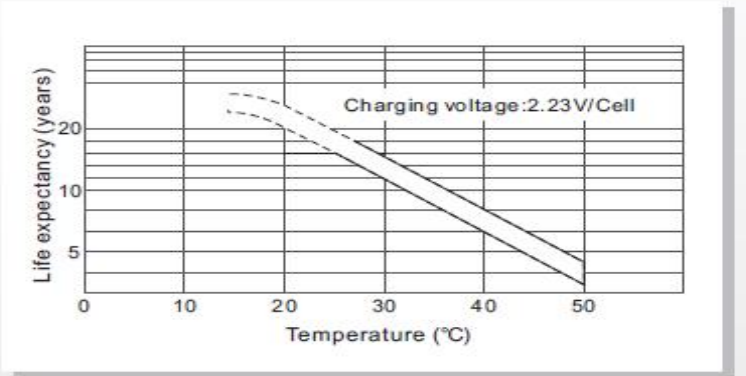

Life Characteristics of Standby use

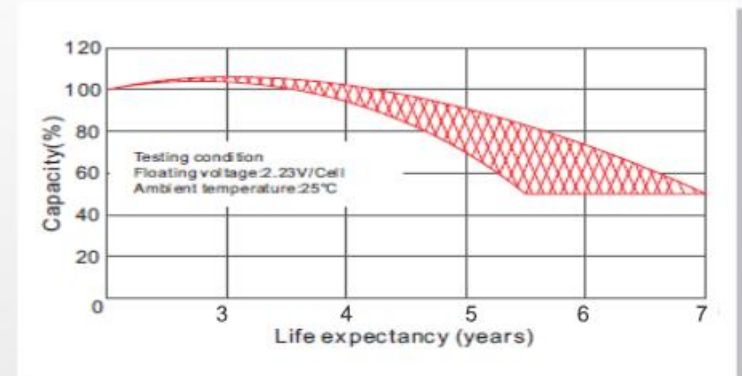

Maintenance & Cautions

- ※ Every month, recommend inspection every battery voltage;
- ※ Every three months, recommend equalization charge once;
Equalization charge method:
Discharge: 100% rate capacity discharge;
Charge: Max. Current 0.3CA, constant voltage 2.35-2.4V/Cell;
- ※ Effect of temperature on float charge voltage: -3mV/Cell;

Contact Us

Add: FL.2, No.12 North Ave.1, Industrial Rd. East, Gusan, Guzhen, Zhongshan, Guangdong, China,
T: +86-760- 8862 5562 | **F:** +86-760-8862 5562
Email: sales@holybattery.com johny5@126.com
Website: www.holybattery.com