



# Holy Enterprise Limited

FL.2, No.12 North Ave.1, Industrial Rd. East, Gusan, Guzhen, Zhongshan, Guangdong, China

## Specification

3-EVF-200-6V200AH/3HR

Cells Per Unit	3
Voltage Per Unit	6
Capacity	200AH@3hr-rate to 1.75V per cell @ 25°C
Weight	Approx.: 35.0kg (Tolerance±3%)
Max. Discharge Current	2000A(5sec)
Internal Resistance	Approx 4.2mΩ
Operating Temperature	Discharge: -20°C~50°C Charge: 0°C~40°C Storage: -20°C~50°C
Normal Operating Temperature	25±3°C
Float Charging Voltage	13.6 to 13.8 VDC/unit Average at 25°C
Maximum Charging Current	37.5A
Equalization and Cycle service	14.5 to 14.9 VDC /unit Average at 25°C
Terminal	Terminal: F14/M8



## Application

Electric golf carts  
Electric wheelchairs  
Cleaning machines  
Electric Vehicles  
Power Tools  
Mowers

Dimension: 260(L) ×180(W) ×278(H) (Total 282 mm)

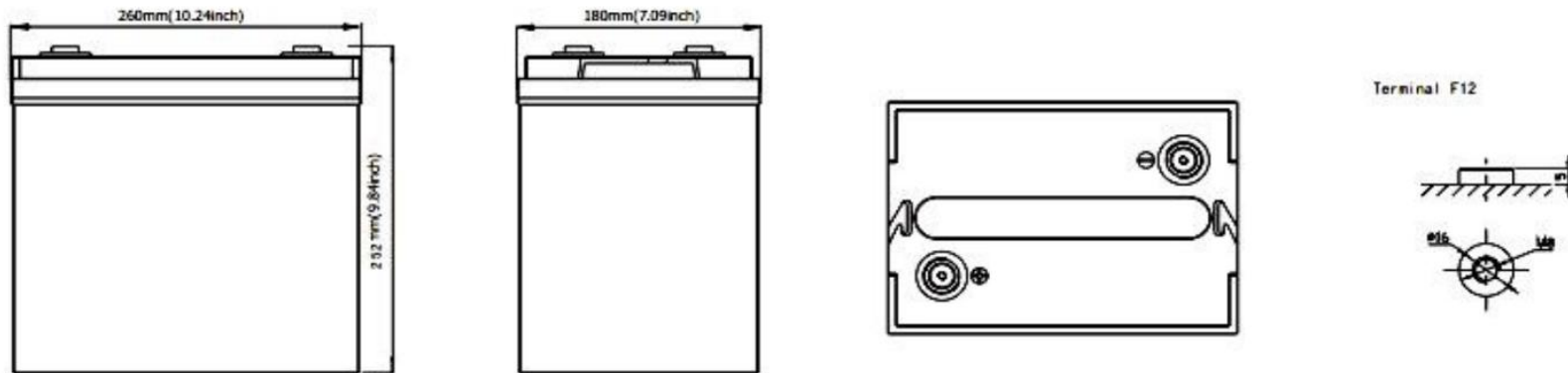

### Constant Current Discharge Characteristics: A(25°C)

F.V/Time	5MIN	10MIN	15MIN	30MIN	1HR	2HR	3HR	4HR	5HR
4.80V	708.6	530.8	448.1	292.9	169.0	101.2	69.90	57.28	46.89
5.00V	688.1	505.1	438.9	288.1	168.2	100.3	69.62	57.01	46.62
5.10V	667.8	487.2	432.0	285.5	166.7	99.60	68.80	56.75	46.34
5.25V	599.6	449.6	411.3	278.4	165.1	98.84	66.95	56.22	45.78
5.40V	541.2	410.0	379.1	266.1	161.2	97.07	64.50	54.90	44.96

### Constant Power Discharge Characteristics: W/Cell(25°C)

F.V/Time	5MIN	10MIN	15MIN	30MIN	1HR	2HR	3HR	4HR	5HR
4.80V	7329	5653	4929	3339	1952	1191	831.7	682.8	559.3
5.00V	7185	5480	4849	3298	1948	1185	832.1	681.9	557.9
5.10V	7103	5335	4795	3275	1933	1178	828.4	680.4	556.0
5.25V	6466	4968	4574	3198	1915	1169	825.2	674.1	549.4
5.40V	5889	4579	4227	3066	1880	1155	802.7	658.7	539.5

All mentioned values are average values.

### Charge Characteristic Curve For Cycle Use(IUI)

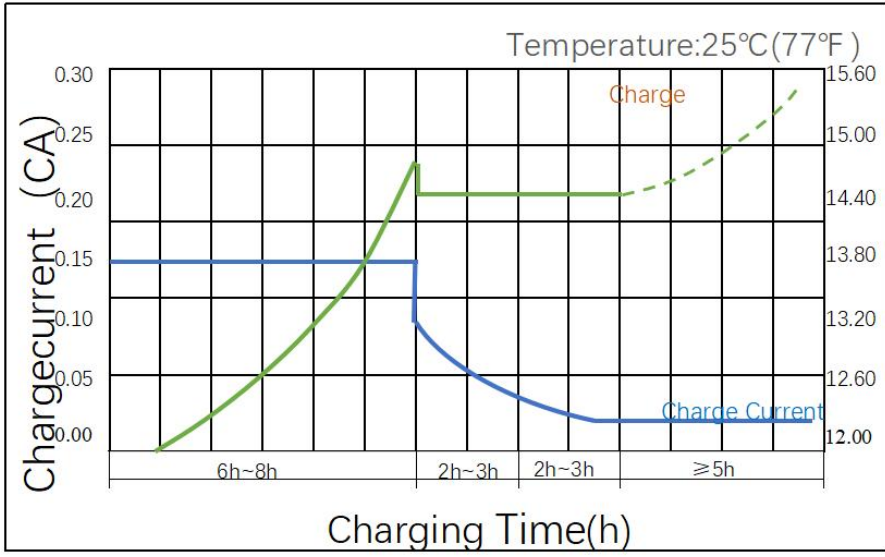

### Cycle Life in Relation to Depth of Discharge

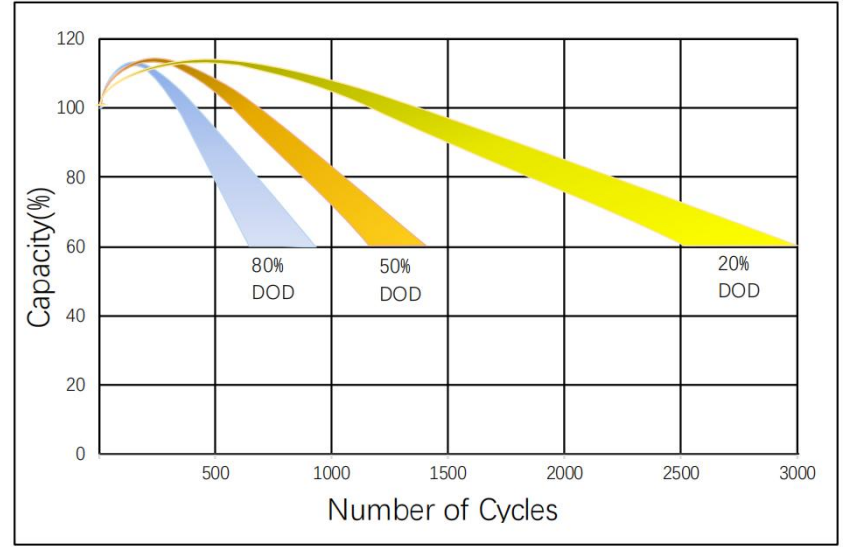

### Storage Characteristics

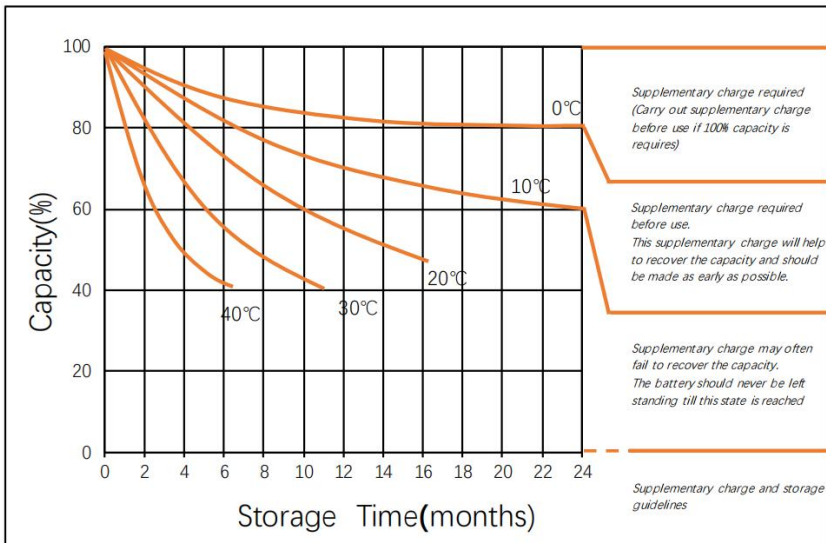

### Discharge Characteristics Curve

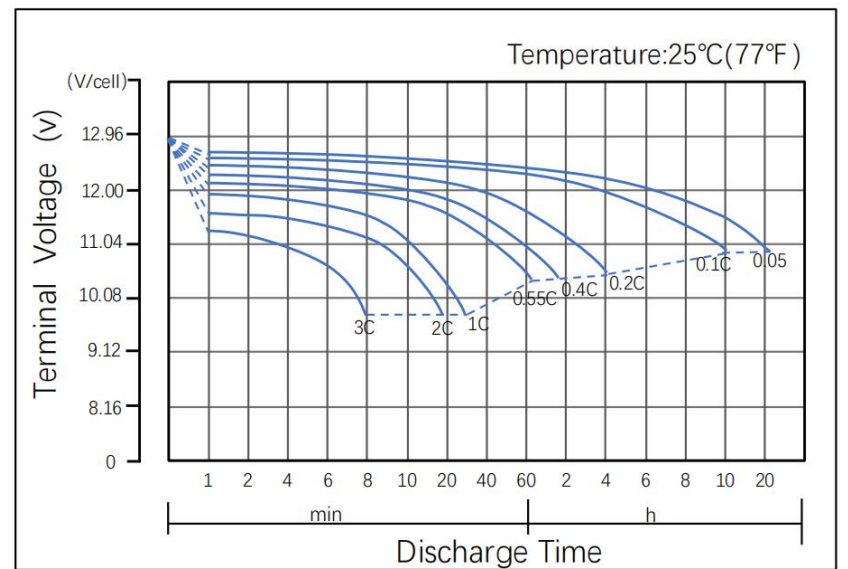

### Relationship Between Charging Voltage and Temperature

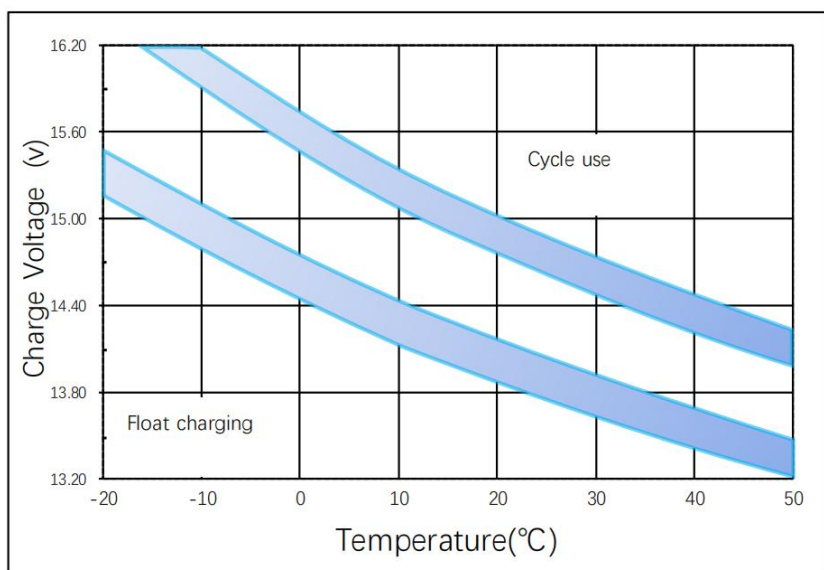

### Temperature Effects on Capacity

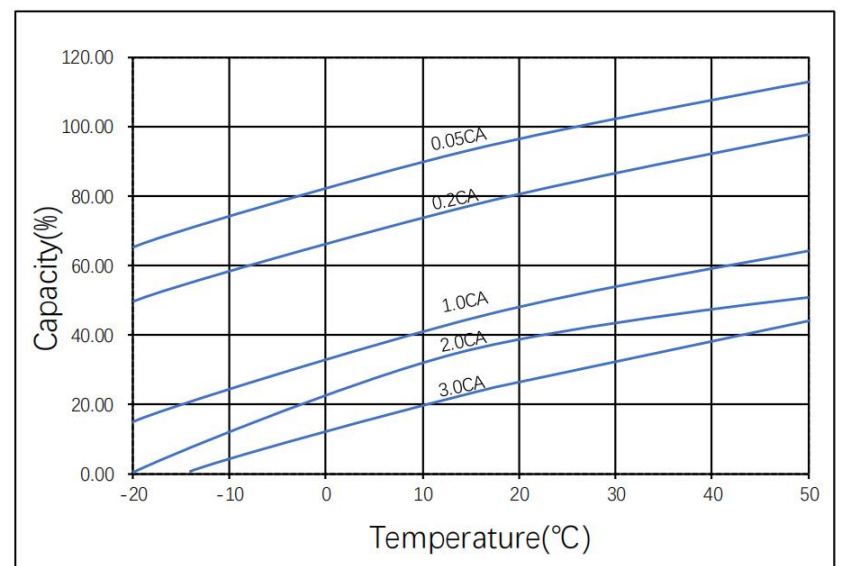

### Maintenance & Cautions

- ※ Every month, recommend inspection every battery voltage;
- ※ Every three months, recommend equalization charge once;  
Equalization charge method:  
Discharge: 100% rate capacity discharge;  
Charge: Max. Current 0.3CA, constant voltage 2.35-2.4V/Cell;
- ※ Effect of temperature on float charge voltage: -3mV/Cell;

### CONTACT Us

**Add:** FL.2, No.12 North Ave.1, Industrial Rd. East, Gusan, Guzhen, Zhongshan, Guangdong, China,  
**T:** +86-760- 8862 5562 | **F:** +86-760-8862 5562  
**Email:** [sales@holybattery.com](mailto:sales@holybattery.com) [johny5@126.com](mailto:johny5@126.com)  
**Website:** [www.holybattery.com](http://www.holybattery.com)