



# Holy Enterprise Limited

FL.2, No.12 North Ave.1, Industrial Rd. East, Gusan, Guzhen, Zhongshan, Guangdong, China

## Specification

OPzV600-2V600AH/10HR

Cells Per Unit	1
Voltage Per Unit	2
Capacity	600AH@10hr-rate to 1.8V per cell @ 25°C
Weight	Approx.47.5kg (Tolerance±3%)
Max. Discharge Current	2500A(5sec)
Internal Resistance	Approx 0.65 mΩ
Operating Temperature	Discharge: -20°C~50°C Charge: 0°C~40°C Storage: -20°C~50°C
Normal Operating Temperature	25±3°C
Float Charging Voltage	2.25 to 2.27 VDC/unit Average at 25°C
Maximum Charging Current	120A
Equalization and Cycle service	2.35 to 2.40 VDC /unit Average at 25°C
Terminal	Terminal: M8



## Application

Uninterruptible Power System;  
Communication Equipments;  
Solar Power Systems;  
Solar Power Street Light;

Dimension: 145(L) ×206(W) ×645(H) (Total 680 mm)

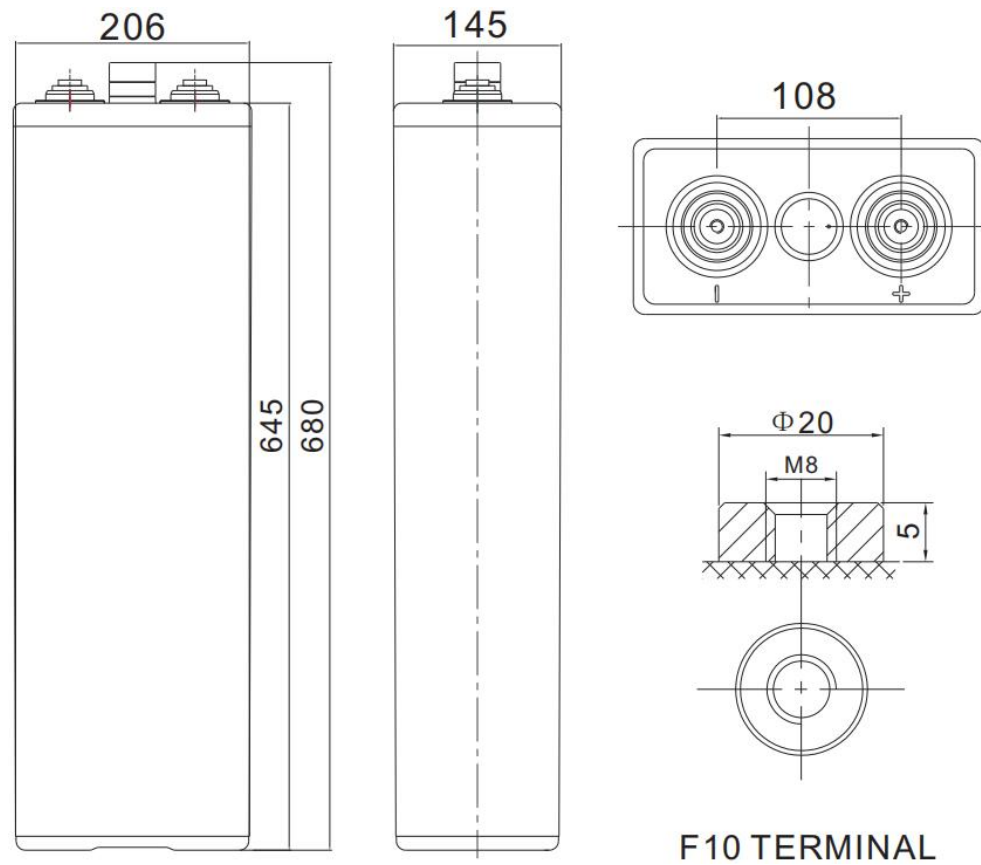

F10 TERMINAL

### Constant Current Discharge Characteristics: A(25°C)

F.V/Time	10MIN	15MIN	30MIN	1HR	2HR	3HR	5HR	8HR	10HR	20HR
1.65V	720.3	608.6	458.4	334.5	213.3	159.5	107.5	74.25	62.10	32.60
1.70V	671.4	577.6	441.4	325.8	209.8	156.5	105.7	43.35	61.80	32.45
1.75V	597.4	528.2	417.0	312.3	204.7	153.6	104.2	72.45	60.90	31.96
1.80V	505.5	472.5	390.3	300.3	197.8	150.3	102.1	71.26	60.00	31.50
1.85V	411.3	389.8	335.3	267.9	180.5	138.1	94.69	66.47	56.10	29.45

### Constant Power Discharge Characteristics: W(25°C)

F.V/Time	10MIN	15MIN	30MIN	1HR	2HR	3HR	5HR	8HR	10HR	20HR
1.65V	1249.2	1080.6	842.2	629.9	407.6	306.8	208.4	146.1	123.0	64.6
1.70V	1184.3	1038.2	817.8	617.8	400.9	301.8	206.6	144.6	122.1	64.1
1.75V	1073.8	965.2	779.8	597.6	392.1	296.7	203.3	143.1	120.9	63.5
1.80V	924.2	874.9	738.9	587.4	383.7	291.6	199.7	141.2	119.1	62.5
1.85V	765.1	733.5	640.1	517.2	350.8	269.3	186.0	132.5	111.9	58.7

All mentioned values are average values.

**Discharge Characteristics(25°C)**

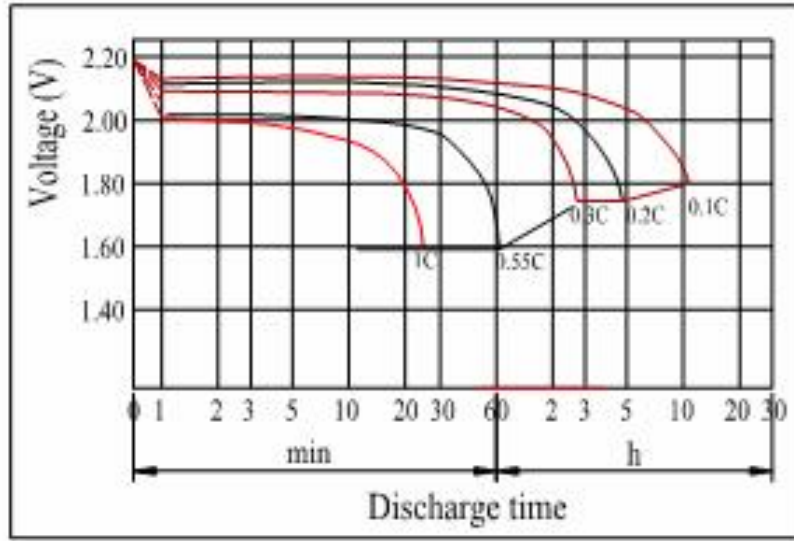

**Charging Characteristics(25°C)**

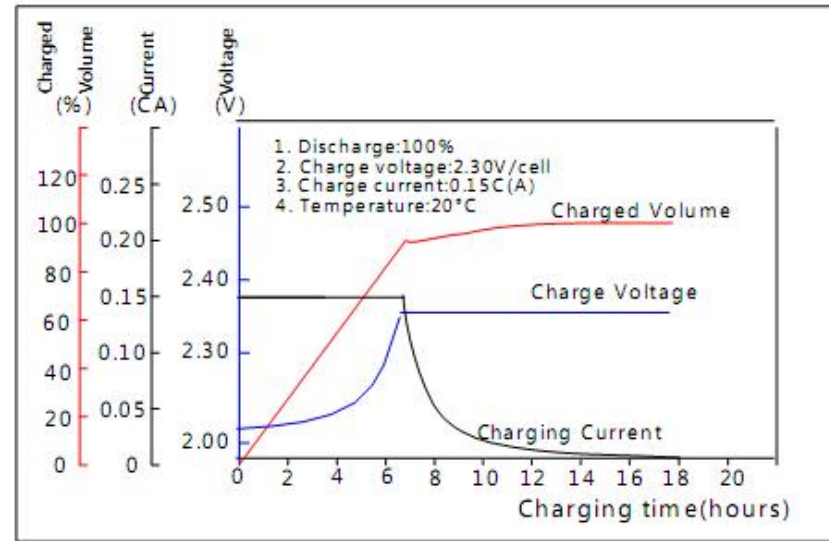

**Effect of Temperature on Capacity**

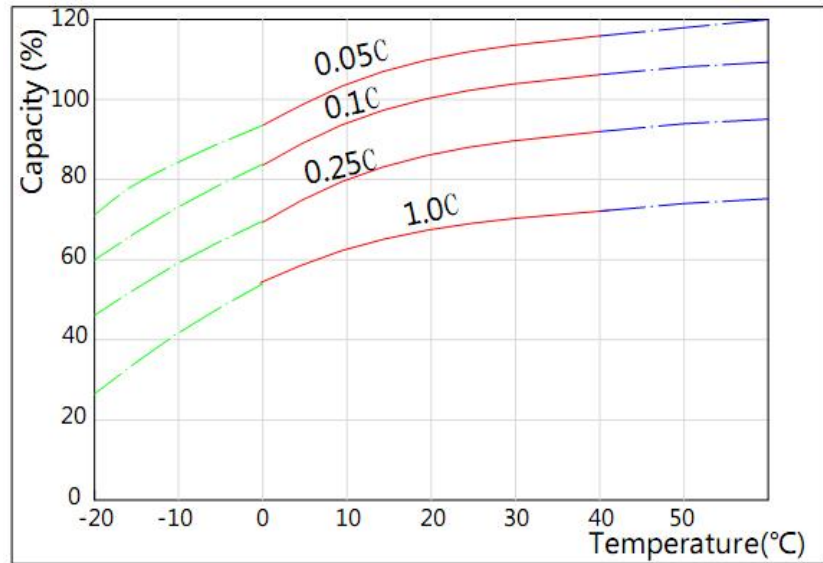

**Self-discharge Characteristics**

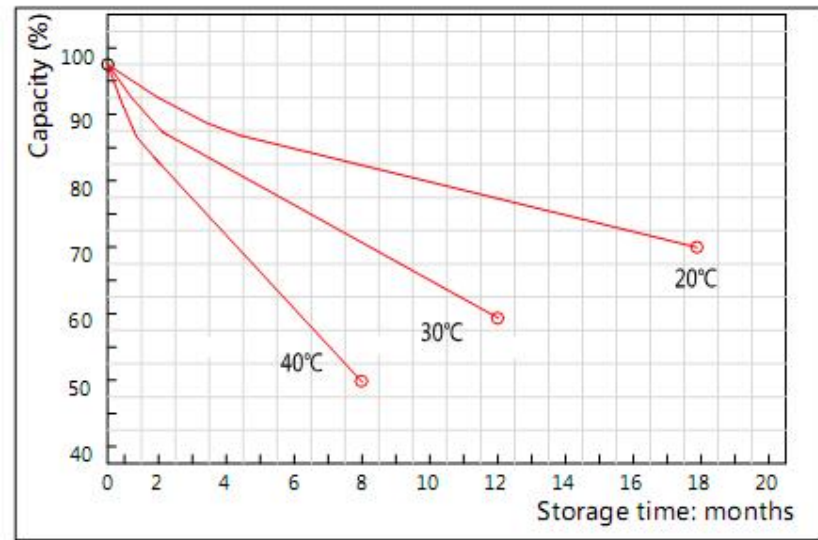

**Open Circuit Voltage and Residual Capacity (25°C)**

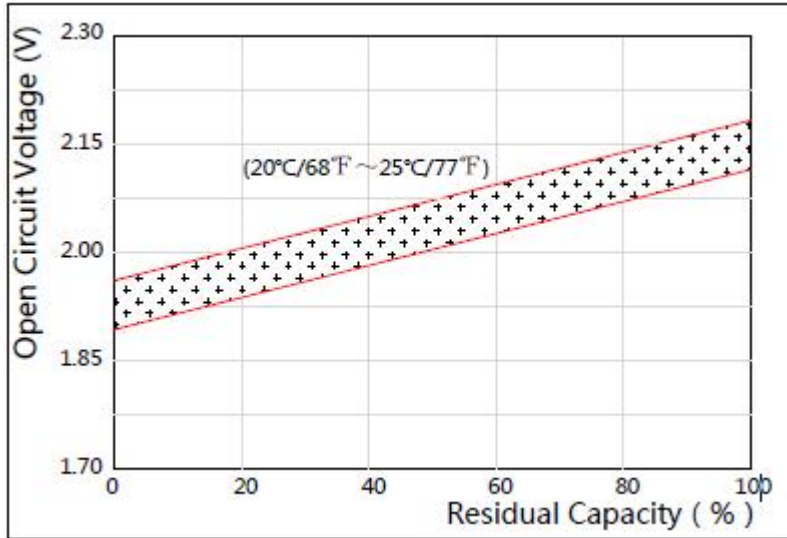

**Charging Voltage and Temperature**

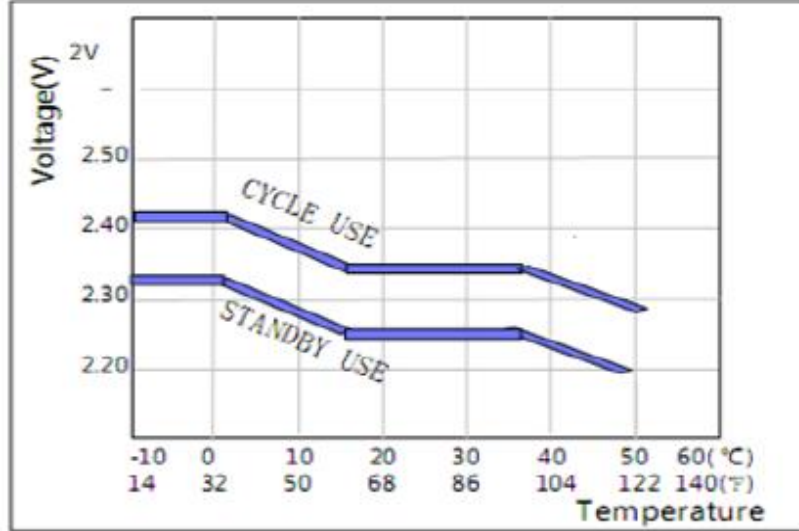

**Floating Life on Temperature**

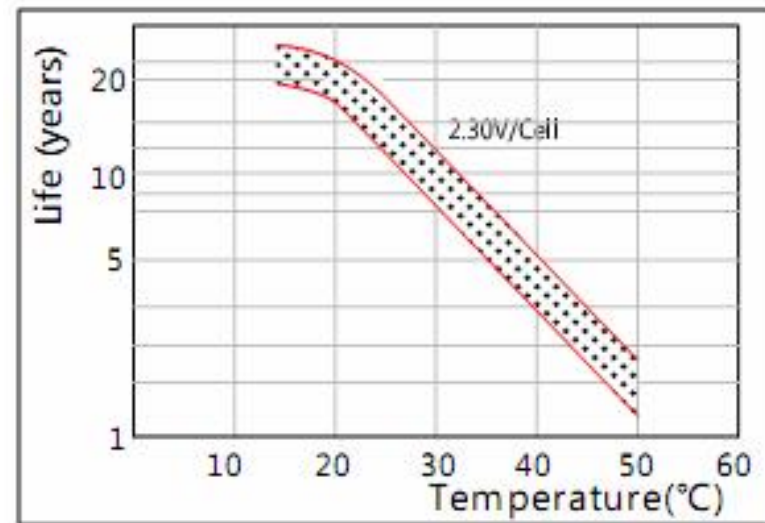

**Cycle Life on D.O.D(25°C)**

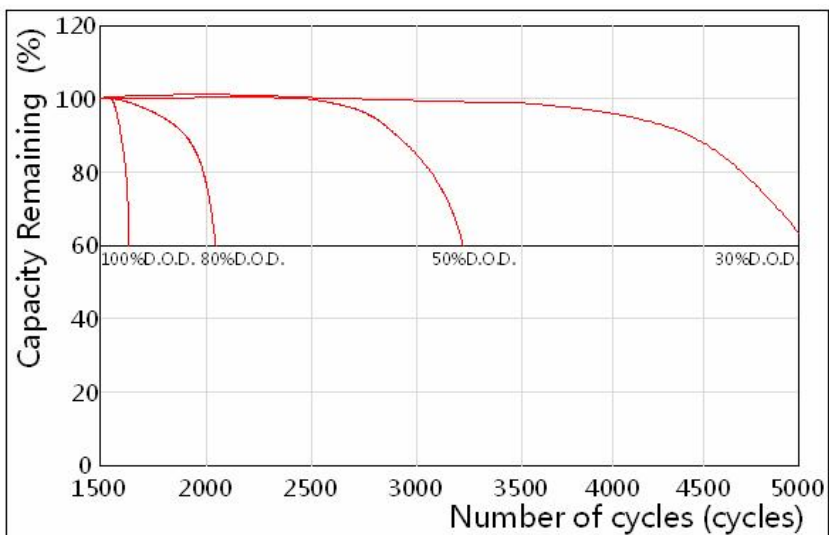

**Maintenance & Cautions**

- ※ Every month, recommend inspection every battery voltage;
- ※ Every three months, recommend equalization charge once;  
Equalization charge method:  
Discharge: 100% rate capacity discharge;  
Charge: Max. Current 0.3CA, constant voltage 2.35-2.4V/Cell;
- ※ Effect of temperature on float charge voltage: -3mV/Cell;

**CONTACT Us**

**Add:** FL.2, No.12 North Ave.1, Industrial Rd. East, Gusan, Guzhen, Zhongshan, Guangdong, China,  
**T:** +86-760-8862 5562 | **F:** +86-760-8862 5562  
**Email:** [sales@holybattery.com](mailto:sales@holybattery.com) [johny5@126.com](mailto:johny5@126.com)  
**Website:** [www.holybattery.com](http://www.holybattery.com)