



Holy Enterprise Limited

FL.2, No.12 North Ave.1, Industrial Rd. East, Gusan, Guzhen, Zhongshan, Guangdong, China

Specification

EV 6-EVF-55-12V55AH/3HR

Cells Per Unit	6
Voltage Per Unit	12
Capacity	55AH@3hr-rate to 1.75V per cell @ 25°C
Weight	Approx.: 18.30kg (Tolerance±3%)
Max. Discharge Current	550A(5sec)
Internal Resistance	Approx 11.7mΩ
Operating Temperature	Discharge: -20°C~50°C Charge: 0°C~40°C Storage: -20°C~50°C
Normal Operating Temperature	25±3°C
Float Charging Voltage	13.6 to 13.8 VDC/unit Average at 25°C
Maximum Charging Current	13.50A
Equalization and Cycle service	14.5 to 14.9 VDC /unit Average at 25°C
Terminal	Terminal: M5



Application

Electric golf carts
Electric wheelchairs
Cleaning machines
Electric Vehicles
Power Tools
Mowers

Dimension: 229(L) ×138(W) ×211(H) (Total 216 mm)

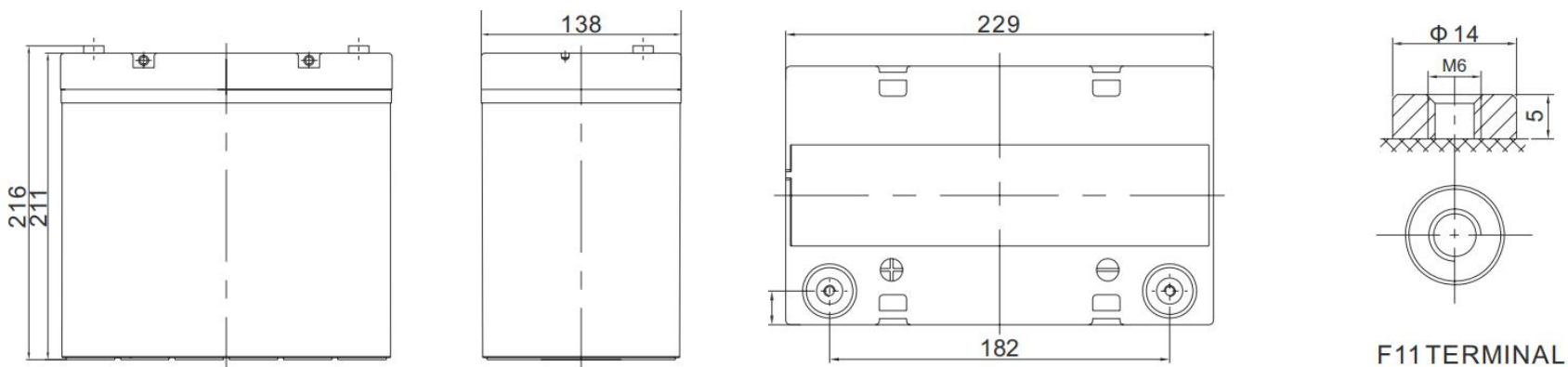

Constant Current Discharge Characteristics: A(25°C)

F.V/Time	5MIN	10MIN	15MIN	30MIN	1HR	2HR	3HR	10HR	20HR
9.60V	234.5	172.7	134.6	82.03	45.50	27.21	18.79	8.42	4.96
10.0V	227.8	164.3	131.9	80.62	45.29	27.01	18.72	8.35	4.89
10.2V	221.0	158.5	129.8	79.13	44.87	26.80	18.57	8.28	4.82
10.5V	198.5	146.3	123.6	78.53	44.45	26.60	18.50	8.21	4.75
10.8V	179.1	133.4	113.9	77.19	43.40	26.12	18.00	8.14	4.67

Constant Power Discharge Characteristics: W/Cell(25°C)

F.V/Time	5MIN	10MIN	15MIN	30MIN	1HR	2HR	3HR	10HR	20HR
9.60V	2474	1839	1468	920.5	525.8	320.7	223.6	88.72	47.50
10.0V	2426	1783	1444	909.3	524.5	319.0	222.8	88.16	46.67
10.2V	2398	1736	1428	902.8	520.5	317.1	222.1	87.38	45.81
10.5V	2183	1616	1362	896.6	515.8	314.8	221.8	86.52	44.94
10.8V	1988	1490	1259	882.2	506.3	310.8	215.8	85.66	44.08

All mentioned values are average values.

Charge Characteristic Curve For Cycle Use(IUI)

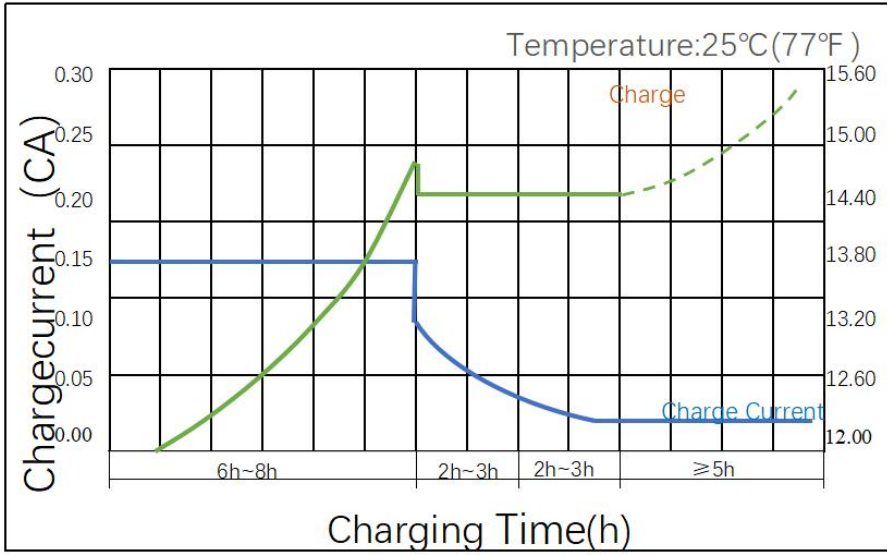

Cycle Life in Relation to Depth of Discharge

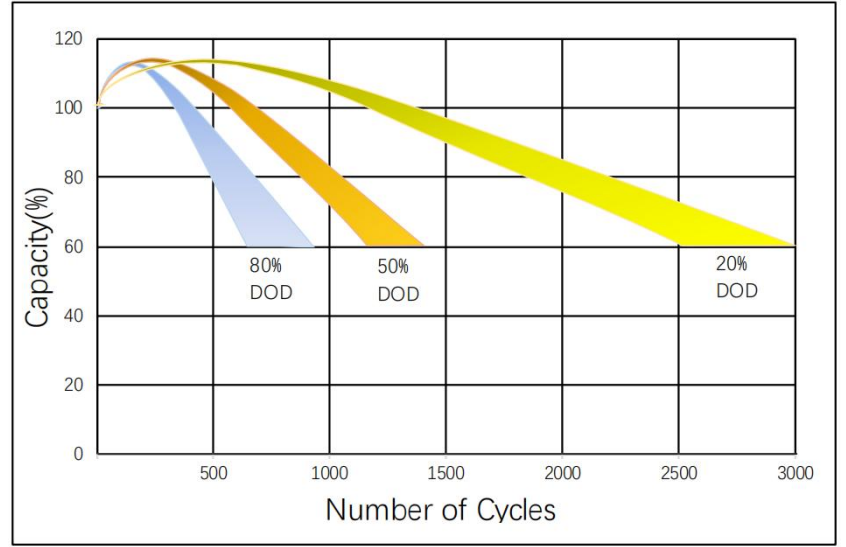

Storage Characteristics

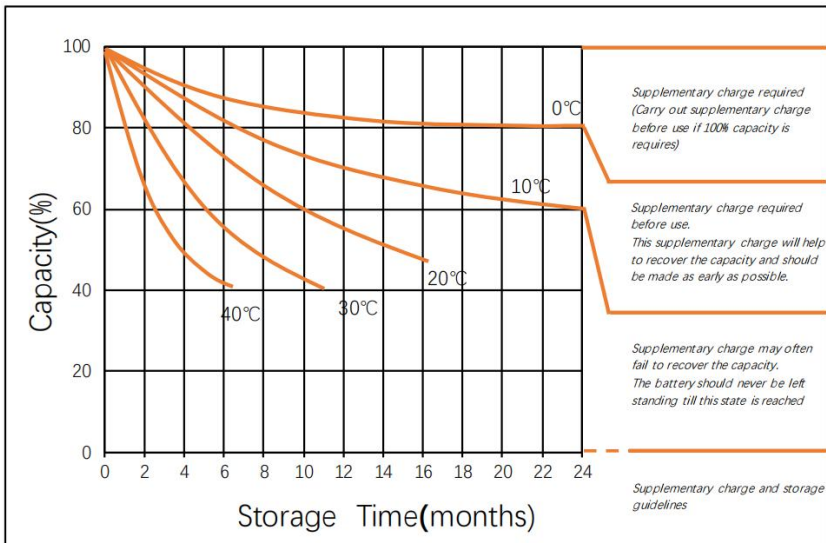

Discharge Characteristics Curve

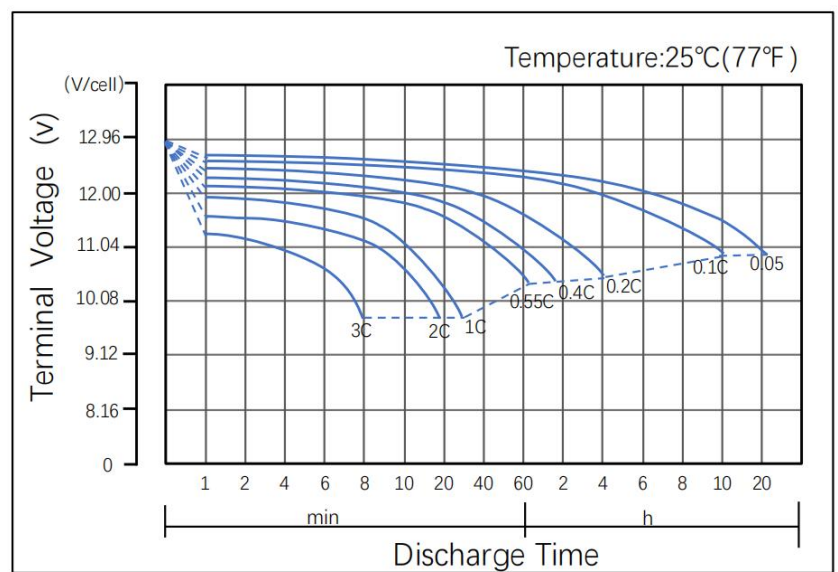

Relationship Between Charging Voltage and Temperature

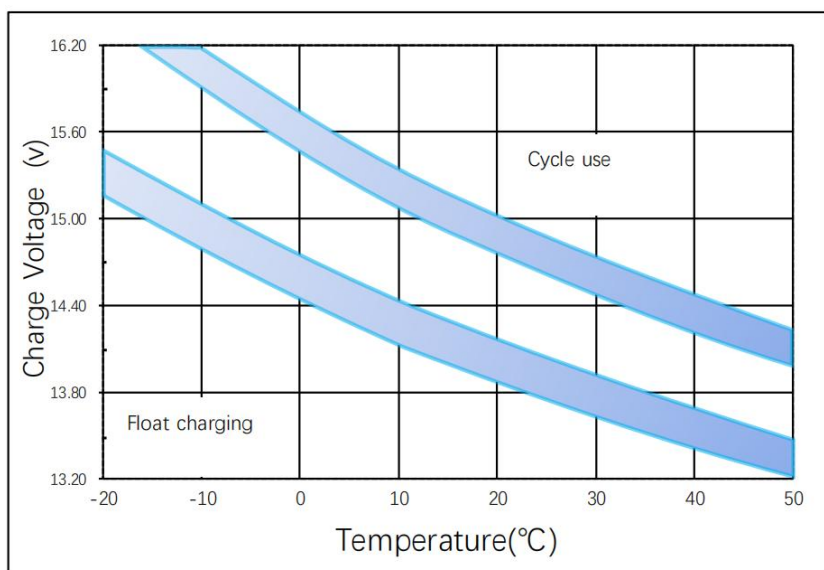

Temperature Effects on Capacity

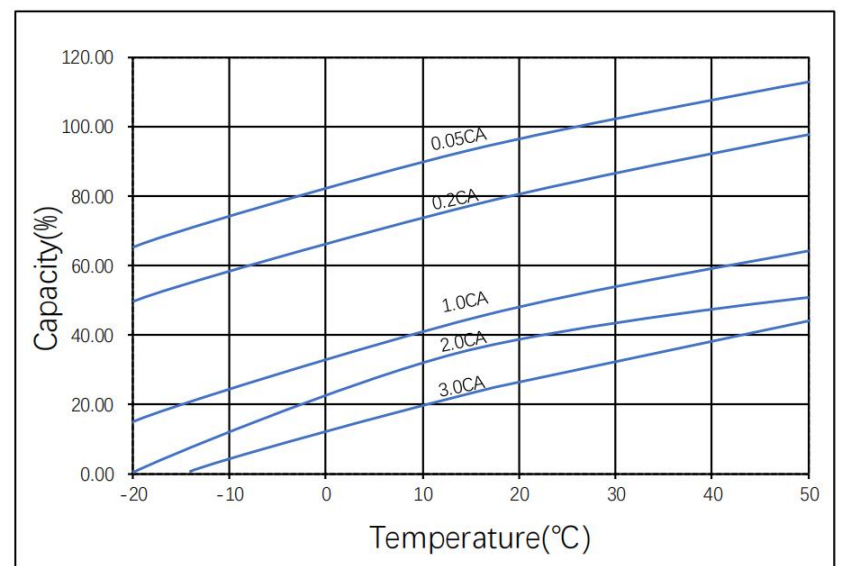

Maintenance & Cautions

- ※ Every month, recommend inspection every battery voltage;
- ※ Every three months, recommend equalization charge once;
Equalization charge method:
Discharge: 100% rate capacity discharge;
Charge: Max. Current 0.3CA, constant voltage 2.35-2.4V/Cell;
- ※ Effect of temperature on float charge voltage: -3mV/Cell;

CONTACT Us

Add: FL.2, No.12 North Ave.1, Industrial Rd. East, Gusan, Guzhen, Zhongshan, Guangdong, China,
T: +86-760- 8862 5562 | **F:** +86-760-8862 5562
Email: sales@holybattery.com johny5@126.com
Website: www.holybattery.com